

Date:..... Location:

Product:..... Project:.....

Quantity:..... Catalog#

Landscape LED Bullet Flood Light



CCT 30/40/50K Tunable



FEATURES

- Beautiful bullet flood landscape lighting
- Easy to install and operate with 30/40/50k tunable colors.
- Energy saving, long lifespan
- Light is soft and uniform, safe to eyes.
- Instant start, NO flickering, NO humming
- Green and eco-friendly without mercury

SUITABLE APPLICATIONS

- Outdoor basketball court, tennis court
- Badminton court, the football field
- The school playground, stadium
- Community leisure entertainment plaza
- Warehouse, factory and workshops
- Highway toll station
- Meeting room, exhibition hall
- Gymnasium and supermarkets, etc. plaza,

CONSTRUCTION:

Heavy die-cast aluminum alloy housing with bronze powder-coated finish.

ELECTRICAL:

Available as 120-277V input, 0-10V dimmable. -40°C to 45°C.

OPTICAL SYSTEM:

Lumileds 2835LED chips. High quality tempered PC lens optics. 38° beam angle.

INSTALLATION & MOUNTING:

Angle-adjustable Knuckle Bracket mount

WARRANTY:

5-year limited warranty. Actual performance may differ as a result of end-user environment and application.

PERFORMANCE

Model NO	Power Factor	Wattage	Voltage/Current Input		Light Efficiency	Kelvin Options
			120V	277V		
AST-FL17-25WBH5DA1	0.9	25W	0.2A	0.36A	128LM/W	3000K/4000K/5000K

Landscape LED Bullet Flood Light

Electric Characteristic

Specification/Model	AST-FL17-25WBH5DA1		
LED Driver	UL listed BHE Brand		
Input power	25W	25W	25W
Lumens output	3200LM	3200LM	3200LM
Efficiency	128LM/W	128LM/W	128LM/W
CRI	>80	>80	>80
Color Temperature	3000K	4000K	5000K
Input voltage	120-277V/AC	120-277V/AC	120-277V/AC
Light distribution type	120D	120D	120D
Working temperature	-40+45°C	-40+45°C	-40+45°C
Junction temperature	<75°C	<75°C	<75°C
lamps efficiency	≥90%	≥90%	≥90%
Certificate	UL CUL DLC	UL CUL DLC	UL CUL DLC
Equivalent	50-100W MH/HPS	50-100W MH/HPS	50-100W MH/HPS

DIMENSION

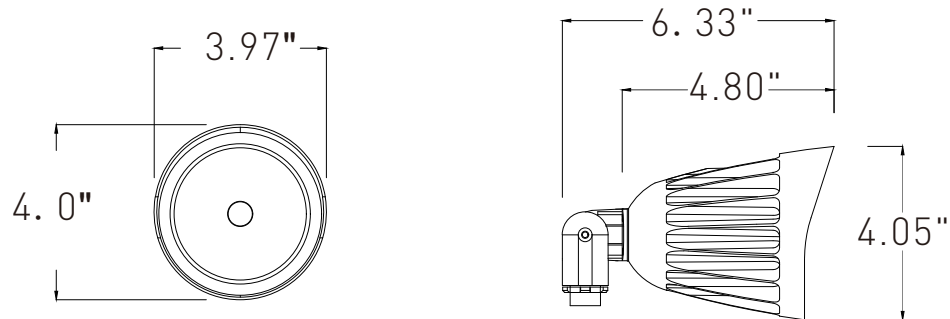

DISTRIBUTION DIAGRAM

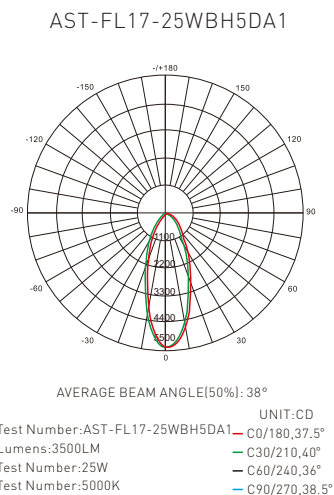

Landscape LED Bullet Flood Light

LED Flood Light Instruction

Cautions:

1. Can not use the electric generator to test the LED light.
2. Please abide by related country, regional and local law and regulations when install this fixture.
3. To avoid electrical shock and damage, please do not install the lights in raining days.
4. Please turn off the power before installation or maintenance. Proper grounding is required to ensure safety.

Notices:

1. To prevent from electric shock or fire risk, installation must be conducted by operator with professional electrical knowledge.
2. Please wear gloves to avoid injury before installing lights.
3. During or after installation, if there are situations such as smoke, fire in the wires or lights, please turn off the power immediately and notify relevant personnel for an overhaul.
4. This light can be used for outdoor installation.

Wiring Diagram:

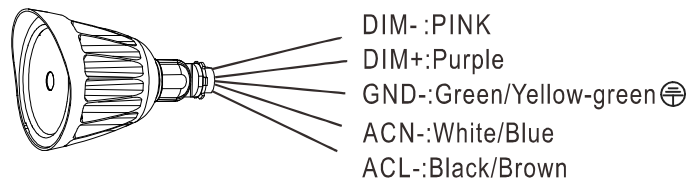

1/2 ADJUSTABLE FITTER MOUNTING (1/2AM)

Step 1: Take the light out of package (Figure 1);

Step 2: Finish wire connection according to the right mode of connection [pay attention to positive wire, negative wire, and ground wire], and then put wire into light pole (Figure 2);

Step 3: Loosen screws; adjust fixture angle as per actual demands and tighten screws later; Tips: Angle of the fixture is adjustable (Figure 3); (pass the bracket through mounting surface, fix it with screws, then connect the wires as per proper wiring requirements.) (Figure 4)

Step 4: when mounting on wall or ceiling with canopy, need to calk the all side to seal the mounting surface. (Figure.5)

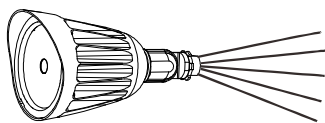

(Figure 1)

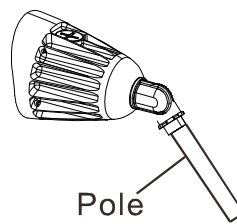

(Figure 2)

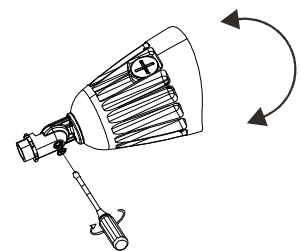

(Figure 3)

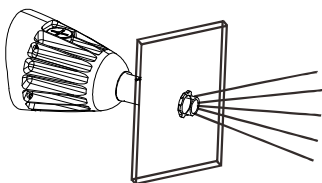

(Figure 4)

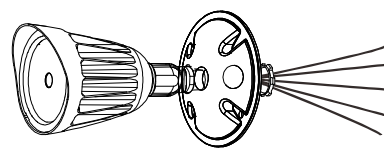

(Figure 5)

Landscape LED Bullet Flood Light

1/2 ADJUSTABLE FITTER MOUNTING (1/2AM)

Step 1: Take the light out of package(Figure6);

Step 2: Finish wire connection according to the right mode of connection (pay attention to positive wire, negative wire, and ground wire), and then put wire into light pole(Figure7);

Step 3: Loosen screws; adjust fixture angle as per actual demands and tighten screws later; Tips: Angle of the fixture is adjustable(Figure8); (pass the bracket through mounting surface, fix it with screws, then connect the wires as per proper wiring requirements.)

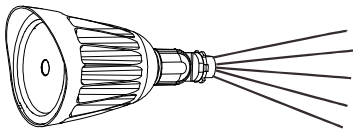

(Figure6)

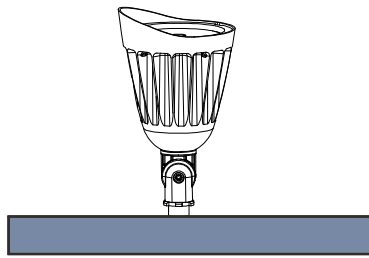

(Figure7)

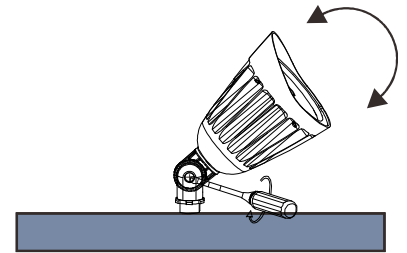

(Figure8)

Function adjustment

Step 1: Open the metal plug and with a screwdriver (figure9), Then slide the switch left and right to adjust the CCT controller, Adjust the color temperature as required (figure10).

Step 2: After adjusting the required control function, tighten the metal plug (figure11).

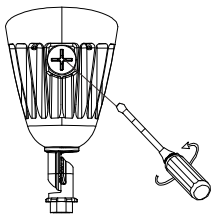

(Figure9)

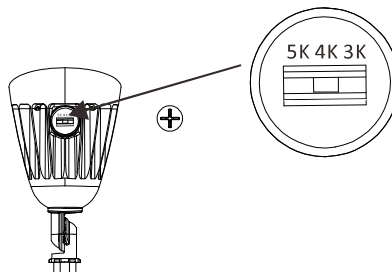

(Figure10)

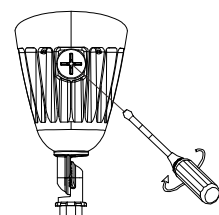

(Figure11)