

60/80/100/120W 3CCT Wall Pack LED



Date: Location:

Product:Project:

Quantity:Catalog#

FEATURES

- 60/80/100/120W Tunable led, 35/40/50K Selectable, universal photocell
- Die-casting aluminum with advanced plastic lense.
- Three quick mount clips allow quick install and maintenance.
- 50000hours life time.

SUITABLE APPLICATIONS

- Warehouses
- Stadiums
- Factories
- Parking Lots
- Shopping Malls
- Supermarkets
- Logistic Centers
- Auto dealerships



CONSTRUCTION:

Heavy die-cast aluminum alloy housing with bronze powder-coated finish.

ELECTRICAL:

Available as 120-277V input. -36°C to 60°C,

OPTICALSYSTEM:

High brightness luminleds2835 chips.high transmittance rate plastic lense 120°beam angle.

INSTALLATION&MOUNTING:

Wall mounting with 3 quick mount clips backside for easy install.

WARRANTY:

5-year limited warranty.Actual performance may differ as result of end-users' environment and application.

CONTROLS&DIMMING

Universal Photocell built in and CCT Power tunable Switch

PERFORMANCE

Model NO	PFC	Wattage	Voltage/Current Input			Light Efficiency	Kelvin Options
			120V	277V	480V		
LS-WP41W-XXK	>0.9	41W	0.34A	0.14A	0.34A	130LM/W	3000K/4000K/5000K
LS-WP60/80/100/ 120W-XXK (CCT&Power Tunable)	>0.9	60W	0.50A	0.21A	0.50A	130LM/W	3000K/4000K/5000K
	>0.9	80W	0.66A	0.28A	0.66A	130LM/W	3000K/4000K/5000K
	>0.9	100W	0.83A	0.36A	0.83A	130LM/W	3000K/4000K/5000K
	>0.9	120W	0.99A	0.43A	0.99A	130LM/W	3000K/4000K/5000K
LS-WP150W-XXK	>0.9	150W	1.25A	0.54A	1.25A	130LM/W	3000K/4000K/5000K

60/80/100/120W 3CCT Wall Pack LED

Special Function

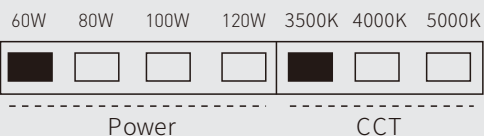
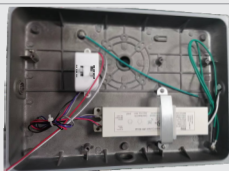

PRODUCT ORDERING GUIDE

LS-WP41W-50K

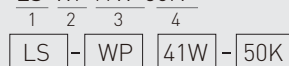

- WP WALLPACK
- 41W Power 41W 60W Power 60W
- 80W Power 80W 100W Power 100W
- 120W Power 120W 150W Power 150W
- 30K CCT:3000K
- 40K CCT:4000K
- 50K CCT:5000K

Electric Characteristic

Specification/Model	LS-WP41W-XXK	LS-WP60/80/100/120W-XXK				LS-WP150W-XXK
LED Driver	ULListed KHM Brand driver					
Input power	41W	60W	80W	100W	120W	150W
Lumens output	5330LM	7800LM	10400LM	13000W	15600W	19500W
Efficiency	130LM/W	130LM/W	130LM/W	130LM/W	130LM/W	130LMW
CRI	>72	>72	>72	>72	>72	>72
Color Temperature	5000K	5000K	5000K	5000K	5000K	5000K
Input voltage	120-277V/AC	120-277V/AC	120-277V/AC	120-277V/AC	120-277V/AC	120-277V/AC
Distribution type	120D	120D	120D	120D	120D	120D
Working temperature	-36+60°C	-36+60°C	-36+60°C	-36+60°C	-36+60°C	-36+60°C
Junction temperature	<75°C	<75°C	<75°C	<75°C	<75°C	<75°C
lamps efficiency	≥90%	≥90%	≥90%	≥90%	≥90%	≥90%
Certificate	ETL CETL DLC	ETL CETL DLC	ETL CETL DLC	ETL CETL DLC	ETL CETL DLC	ETL CETL DLC
Equivalent	70-100WMH/HPS	100-150WMH/HPS	150-175WMH/HPS	175-200WMH/HPS	200-250WMH/HPS	250-400WMH/HPS

DIMENSION

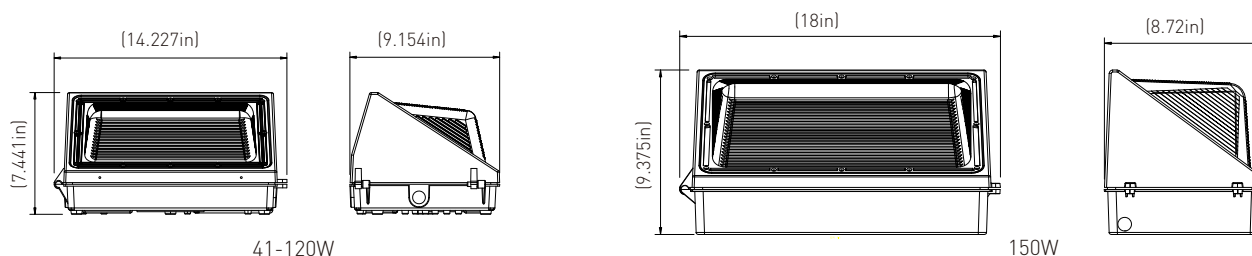

60/80/100/120W 3CCT Wall Pack LED

DISTRIBUTION DIAGRAM

LS-WP41W-50K

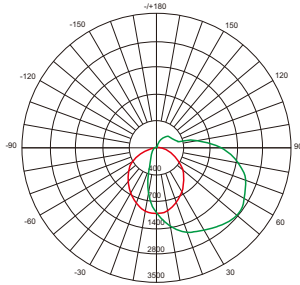

AVERAGE BEAM ANGLE(50%): 118.3°

UNIT:CD
 Test Number:LS-WP41W-50K
 Lumens:5330LM
 Test Number:41W
 Test Number:5000K

— C0/180,113.7
 — C30/210,100.1
 — C60/240,108.6
 — C90/270,130.9

LS-WP60W-50K

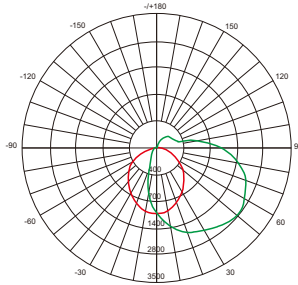

AVERAGE BEAM ANGLE(50%): 118.3°

UNIT:CD
 Test Number:LS-WP60W-50K
 Lumens:7800LM
 Test Number:60W
 Test Number:5000K

— C0/180,113.7
 — C30/210,100.1
 — C60/240,108.6
 — C90/270,130.9

LS-WP80W-50K

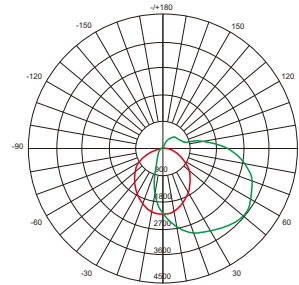

AVERAGE BEAM ANGLE(50%): 119.2°

UNIT:CD
 Test Number:LS-WP80W-50K
 Lumens:10400LM
 Test Number:80W
 Test Number:5000K

— C0/180,115.4
 — C30/210,121.0
 — C60/240,108.4
 — C90/270,132.1

LS-WP100W-50K

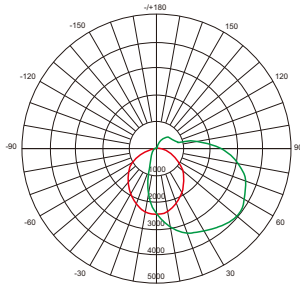

AVERAGE BEAM ANGLE(50%): 120.9°

UNIT:CD
 Test Number:LS-WP100W-50K
 Lumens:13000LM
 Test Number:100W
 Test Number:5000K

— C0/180,120.1
 — C30/210,120.9
 — C60/240,111.3
 — C90/270,131.4

LS-WP120W-50K

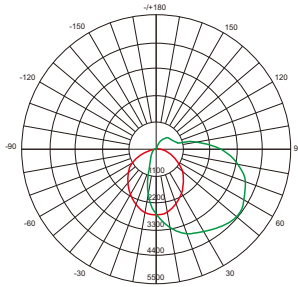

AVERAGE BEAM ANGLE(50%): 119.7°

UNIT:CD
 Test Number:LS-WP120W-50K
 Lumens:15600LM
 Test Number:120W
 Test Number:5000K

— C0/180,104.2
 — C30/210,109.6
 — C60/240,116.8
 — C90/270,108.3

LS-WP150W-50K

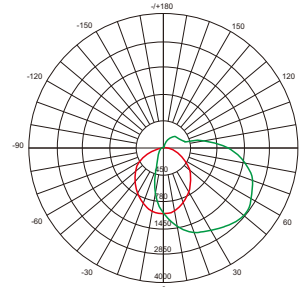

AVERAGE BEAM ANGLE(50%): 115.8°

UNIT:CD
 Test Number:LS-WP150W-50K
 Lumens:19500LM
 Test Number:150W
 Test Number:5000K

— C0/180,115.5
 — C30/210,102.3
 — C60/240,109.8
 — C90/270,140.6

Installation Instruction

1. Use a screw driver to unscrew the lamp and remove the upper half of the fixture.

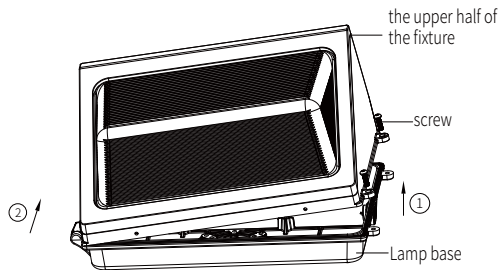

2. Unscrew the cover of the entry hole on the lamp base and remove the cover.

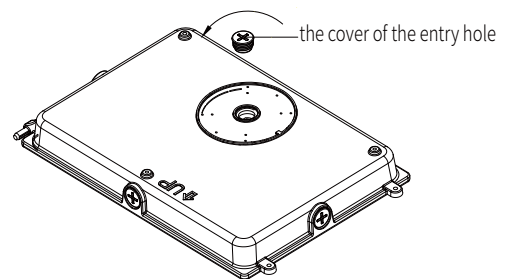

60/80/100/120W 3CCT Wall Pack LED

3. According to the embedded terminal box, punch the corresponding mounting hole on the light's mount.

Mounting holes on the light's mount

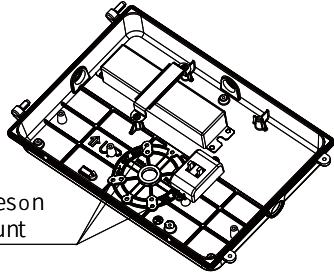

4. Put the input wire in the embedded box passes through the waterproof pad and then pass through the lamp base.

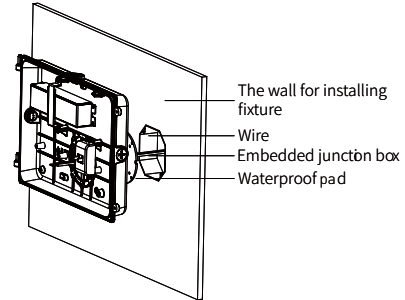

5. Use screw to lock the lamp base on the embedded junction box.

Screw

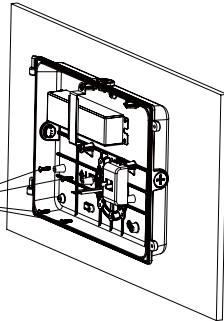

6. Connect the input wire and the dimming wire of the light, then put the connected wires into the embedded terminal box.

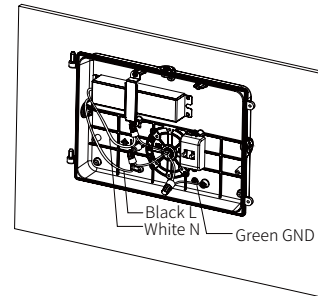

7. Connect the output wires of driver with the wires of PCB board. Please use "Dipper Switch", to achieve "Power and CCT Tunable" function.

Connect

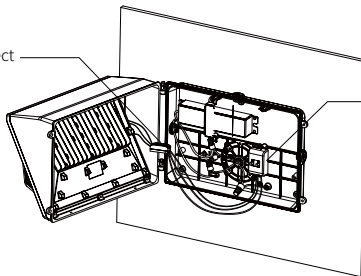

Dipper switch for "Power and CCT Tunable"

8. Use screws to lock the fixture. Installation completed.

