

V11 UFO HIGHBAY LED LIGHT

Date: Location:

Product: Project:

Quantity: Catalog#



FEATURES

- Super Brightness LED Efficiency
- 5ft cable, Occupancy Sensor Options
- Black or White housing Option, Kelvin options, Voltage options
- Heavy weight Aluminum Alloy
- Corrosion and rust proof
- Easy installation and maintenance

SUITABLE APPLICATIONS

- Warehouse
- Manufacturing facilities
- Convention Centers
- Sporting arenas
- Big-box retail stores
- Cold storage facilities
- Gymnasiums



CONSTRUCTION:

Heavy die-cast Aluminum Alloy housing,
Black or White Housing options

ELECTRICAL:

Available as 120-277V or 277-480V input. -36+60°C

OPTICAL SYSTEM:

High Lumen Lumileds SMD 2835 LED Chip. High transparency,
PC cover, 120 beam angle

INSTALLATION & MOUNTING:

Suspend Mounting with unique hook

WARRANTY:

5-year limited warranty. Actual performance may differ as a result of end-user environment and application.

CONTROLS & DIMMING

0-10V dimmable as standard. Occupancy sensor options

PERFORMANCE

Model NO	Power factor	Wattage	Voltage/Current Input		Light Efficiency	Kelvin Options
			120V	277V		
AST-HB23-240WS1XYA1	>0.9	150W	1.25A	0.54A	160LM/W	4000K/5000K/5700K
	>0.9	200W	1.66A	0.72A	160LM/W	4000K/5000K/5700K
	>0.9	240W	2.50A	0.86A	160LM/W	4000K/5000K/5700K

V11 UFO HIGHBAY LED LIGHT

OPTIONAL ACCESSORIES



Emergency Battery Backup, Style
EMUFO-40170-YY



Dimming Microwave Motion Sensor,
Style:HB01DMS-A.



PC or Aluminum reflector cover
options



Safe Cord

PRODUCT ORDERING GUIDE

AST-HB23-240WS1XYA1
1 2 3 4 5

AST - HB23 - 240W S1 XYA1

- AST Company name
- HB23 Product series, LED High Bay Light
- 240W Watt tunable Power 150W-200W-240W
- S1 Driver manufacturer, Sosen CNL-E series
- XYA1 can be any alphabet for manufacturer of LED

Electric Characteristic

Specification/Model	AST-HB23-240WS1XYA1		
LED Driver	UL Listed 0-10V Dimmable	UL Listed 0-10V Dimmable	UL Listed 0-10V Dimmable
Input power	150W	200W	240W
Lumens output	24000LM	32000W	38400LM
Efficiency	160LM/W	160LM/W	160LM/W
CRI	>80	>80	>80
Color Temperature	4000K 5000K 5700K	4000K 5000K 5700K	4000K 5000K 5700K
Input voltage	120-277V/AC	120-277V/AC	120-277V/AC
Light distribution type	120D	120D	120D
Working temperature	-36+60°C	-36+60°C	-36+60°C
Junction temperature	<75°C	<75°C	<75°C
lamps efficiency	≥90%	≥90%	≥90%
Certificate	UL CUL DLC	UL CUL DLC	UL CUL DLC
Equivalent	200-250W MH/HPS	250-600W MH/HPS	600-750W MH/HPS

V11 UFO HIGHBAY LED LIGHT

DIMENSION

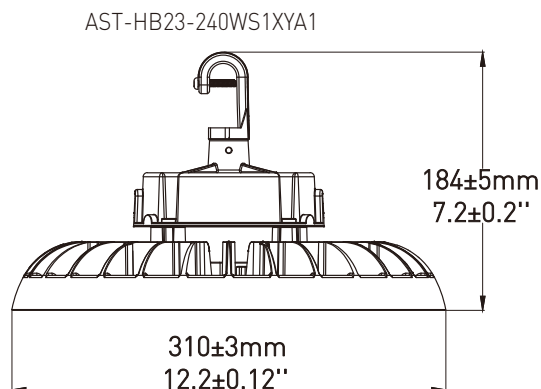

DISTRIBUTION DIAGRAM

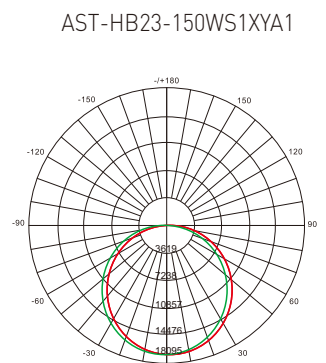
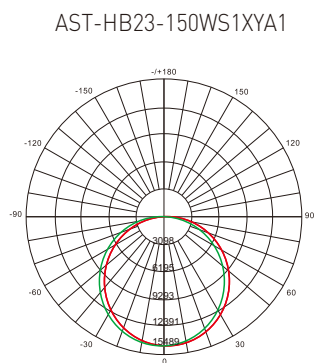
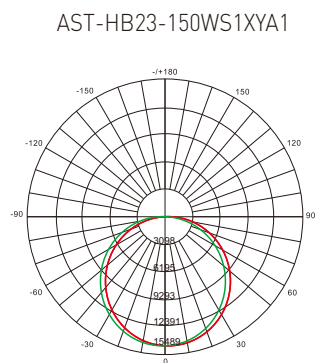

LED High Bay Light Installation

Cautions:

1. Do not use any electric generator to test the LED light.
2. Please abide by related country, regional and local law and regulations when installing this fixture.
3. Please turn off the power before installation or maintenance.
4. Proper earth grounding is required to ensure safety.

Notice

1. To avoid possibility of electrical shock or fire, the installation personnel must have professional electric knowledge.
2. Please wear gloves to avoid injury before installation.
3. If any smoke or spark of the wire happened, please turn off the power immediately and notify relevant personnel.
4. Please use listed water proof strain relief bushing when connecting the supply cord to the outlet box.

Attention:

1. Please check if there is any damage during shipping. If so, please contact manufacturer timely.
2. Please read the installation instruction carefully to check whether all the accessories are complete. After confirmation, install the fixture according to installation steps.

V11 UFO HIGHBAY LED LIGHT

Wiring Diagram & Instruction:

3 dimming functions are available in this high bay light:

1. Constant current can be achieved by 0-10V Dc dimming;
2. PWM signal dimming;
3. Variation of resistance unit dimming. .

Description : This product is 0/1-10V dimming, below dimmers are recommended	
Brand	Model
LUTON	NTST V-DV
LEVI TON	DS710-10 Z / IP710
LEGRAN D	RH4FBL3P W

Wiring Instruction:

ACL:Black/Brown, ACN:White/Blue ⊕ Green/Yellow, DIM +: Purple, DIM -: Pink, AUX:Black/White, (As for the wire color of DIM+ and DIM-. pls check the right label)

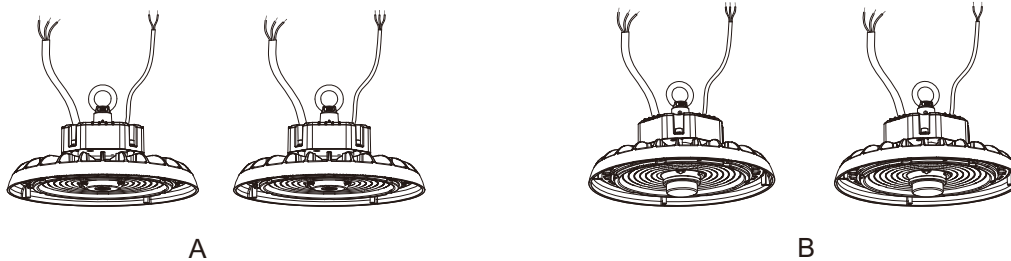

Please choose the appropriate dimming way according to your needs. You can also choose not to use this function.

*The product can not be connected to a dimming device when its equipped with Motion Sensor.

Installation Methods: Hook Mount, Ceiling Mount, 1/2" NPT Mount. (Please choose the most suitable installation method for the purchased product as per your needs)

A. Hanging Mount: (Hook or eyebolt)

Step1. Screw the hook into the fixture, tighten and fix it. (figure 1)

Step2. Fix screws into the holes with a hammer. (Figure 4)

Step3. After installation, connect the wire of the fixture to the mains according to local wiring rules, ensure the connection is stable and make good protection on the connection.



Figure 1

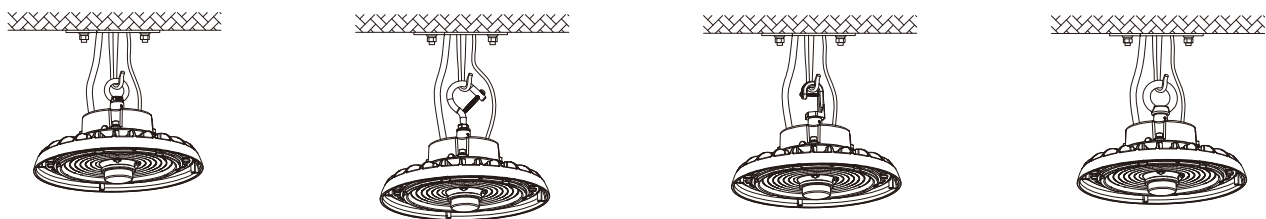

Figure 2

B. Ceiling Mount:

Step1. Mark with a mark pen or sharp tool on the mounting surface and drill. (Figure 3)

Step2. Fix screws into the holes with a hammer. (Figure 4)

Step3. Align the bracket hole with screw hole (Figure 5), and push the fixture to one side (Figure 6) and fix it.

Step4 After installation, connect the wire of the fixture to the mains according to local wiring rules, ensure the connection is stable and make good protection on the connection. By adjusting the brackets screws, users can adjust 50° to the left or right vertically. (Figure 7)

V11 UFO HIGHBAY LED LIGHT

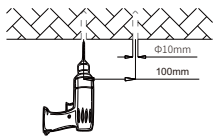

Figure 3

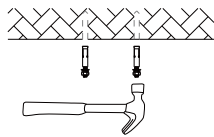

Figure 4

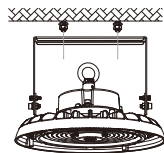

Figure 5

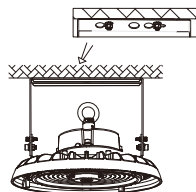

Figure 6

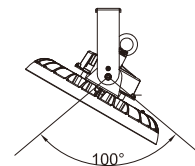

Figure 7

C.1/2"NPT Mount:

Step1. Unscrew the nuts on 1/2" NTP. (Figure 8)

Step2. Insert 1/2" NTP stem into the bracket hole. (Figure 9)

Step3. Re-screw the nuts. (Figure 10),After installation, connect the wire of the fixture to the mains according to local wiring rules, ensure the connection is stable and make good protection on the connection. By adjusting the brackets screws, users can adjust 50° to the left or right vertically.

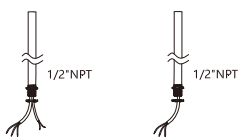

Figure 8

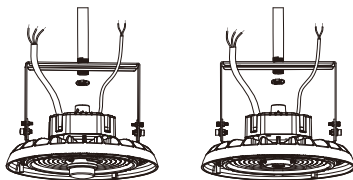

Figure 9

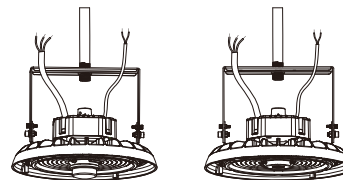

Figure 10

Extra Accessory Option Installation: 1:Wire Guard, 2:Motion Sensor/ PIR Sensor, 3: Aluminum reflector/PC reflector 4: Safety cable:

1. Wire Guard: (Purchase the correct size wire guard from manufacturer)

Place the wire guard on the lamp and fix it with screws. (Figure 11)

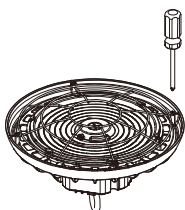

Figure 11

2. DC Motion Sensor 1 PIR Sensor (Both sensors are with the same installation method)

Step1. Use a screwdriver to remove the 1/2 plug from the sensor; (Figure 12)

Step2. Twist-lock the DC sensor to the base to make it work properly, use a remote control to adjust the working mode as per demand. (Figure 13)



Figure 12

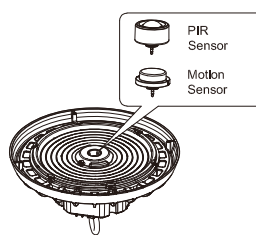

Figure 13

V11 UFO HIGHBAY LED LIGHT

3: Aluminum reflector | PC reflector

Step1. Lock the PC reflector or Aluminum reflector to the lamp with screws.
step2. Installation complete. (Figure 14)

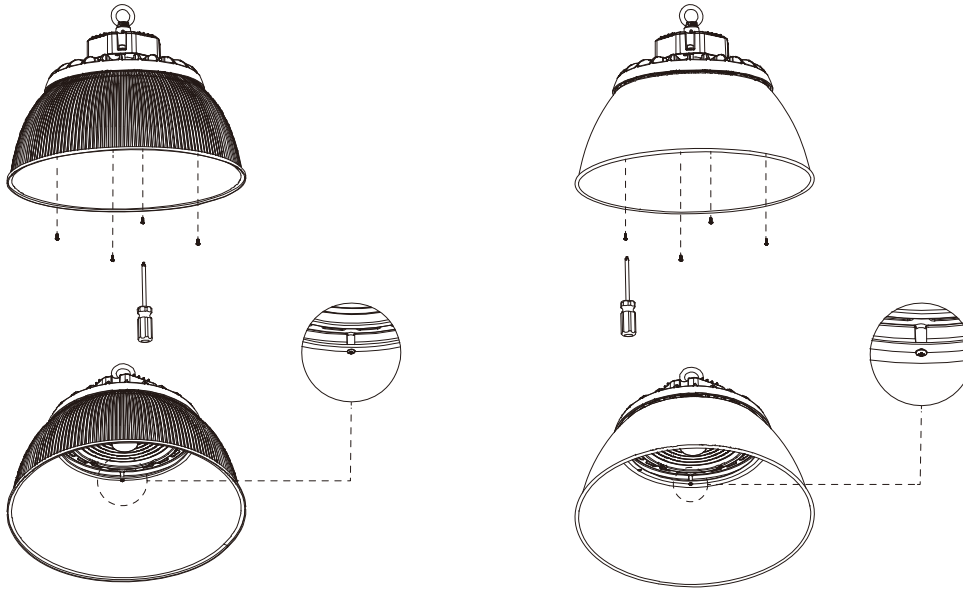

Figure 14

4: Safety cable;

Step1. Fix the safety rope on the lamp body with screws. (Figure 15)
Step2. Fix the safety buckle on the rail, and the installation is finished.

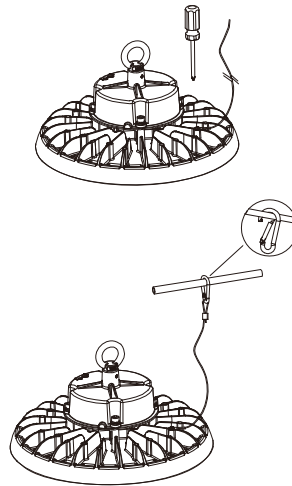

Figure 15