

Date:..... Location:

Product:..... Project:.....

Quantity:..... Catalog:.....

V4 Garage Parking Lot LED Light

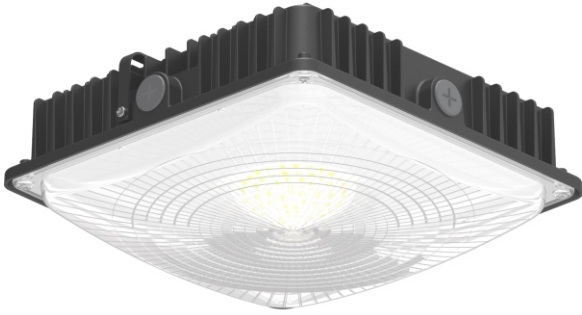

FEATURES

- 30/45/70w tunable, 3/4/5K selectable.
- Built in Motion sensor receptacle port
- Wide beam angle with anti-UV PC optics.
- Anti-corrosion and rust proof
- 50,000 hours lifetime, DLC PREMIUM

SUITABLE APPLICATIONS

- Shopping mall/Building/Airport Garage Parking lot lighting
- Underground Garage Parking lot lighting

CONSTRUCTION:

Heavy die-cast aluminum alloy housing bronze powder-coated finish.

ELECTRICAL:

Available as 120-277V input. -20°C to 45°C.

OPTICAL SYSTEM:

Lumileds 2835LED chips. High quality light transmission PC optics.150° beam angle.

INSTALLATION&MOUNTING:

ceiling mount or 3/4" conduit entry on top for pendant mounting (pendant provided by others)

WARRANTY:

5-year limited warranty. Actual performance may differ as a result of end-user environment and application.

PERFORMANCE

LS-4NCP(70/45/30W)-XXK

Wattage	Power Factor	Motion Detection	Voltage/CurrentInput		Light Efficiency	CCT tunable
			120V	277V		
30W	0.9	40FT	0.25A	0.11A	130LM/W	3000K/4000K/5000K
45W	0.9	40FT	0.37A	0.16A	130LM/W	3000K/4000K/5000K
70W	0.9	40FT	0.58A	0.25A	130LM/W	3000K/4000K/5000K

V4 Garage Parking Lot LED Light

Motion Sensor Compatible

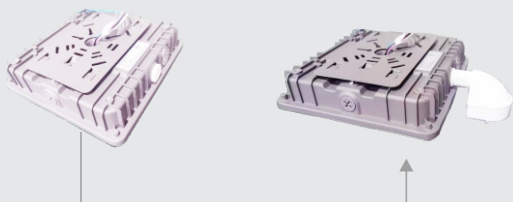

HD07VR-MH Occupancy sensor: plug and play

CCT & Power Adjustable

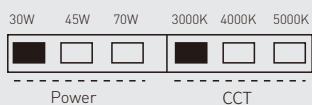

The lamps has switches for adjusting power and color temperature

PRODUCT ORDERING GUIDE

LS-4NCP(70/45/30W)-XXK

1 2 3 4
 LS - 4NCP 70/45/30W - XXK

LS

4NCP G4 New canopy

Power Tunable

70W Power 70W 45W Power 45W
 30W Power 30W

XXK:CCT Tunable

30K CCT:3500K
 40K CCT:4000K
 50K CCT:5000K

Electric Characteristic

Specification/Model	LS-4NCP70/45/30W-XXK	LS-4NCP70/45/30W-XXK	LS-4NCP70/45/30W-XXK
LED Driver	UL 0-10V Dimmable		
Input power	70W	45W	30W
Lumens output	9100LM	5850LM	3900LM
Light Efficiency	130LM/W	130LM/W	130LM/W
CRI	>80	>80	>80
Color Temperature	3000K/4000K/5000K	3000K/4000K/5000K	3000K/4000K/5000K
Input voltage	120-277V/AC	120-277V/AC	120-277V/AC
Light distribution type	150D	150D	150D
Working temperature	-20+45°C	-20+45°C	-20+45°C
Junction temperature	<75°C	<75°C	<75°C
Lamp Efficiency	≥90%	≥90%	≥90%
Certificate	ETL CETL DLC	ETL CETL DLC	ETL CETL DLC
Equivalent	180-250W MH/HP S	120-180 W MH/HPS	80-120W MH/HP S

V4 Garage Parking Lot LED Light

DIMENSION

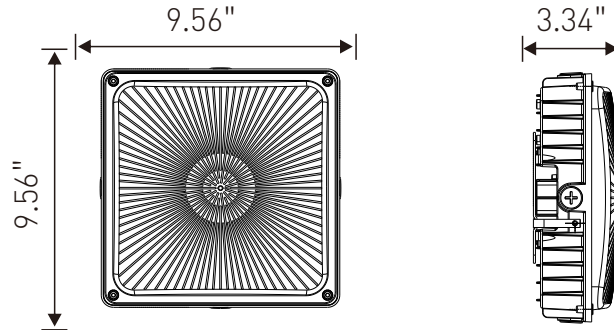

DISTRIBUTION DIAGRAM

LS-4NCP70/45/30W-XXK

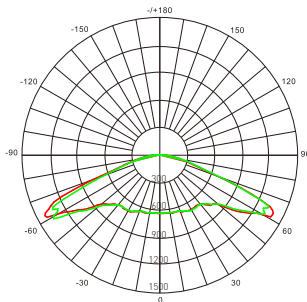

AVERAGE BEAM ANGLE[50%]: 150°
 UNIT:CD
 Lumens:3900LM
 Test Number:30W
 Test Number:5000K

— C0/180, 154
— C30/210,111.5
— C60/240,109.7
— C90/270,154.2

LS-4NCP70/45/30W-XXK

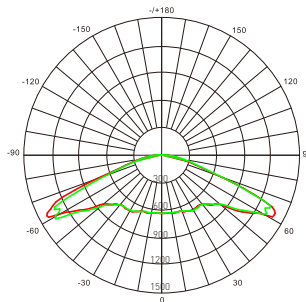

AVERAGE BEAM ANGLE[50%]: 150°
 UNIT:CD
 Lumens:7800LM
 Test Number:45W
 Test Number:5850K

— C0/180, 154
— C30/210,111.5
— C60/240,109.7
— C90/270,154.2

LS-4NCP70/45/30W-XXK

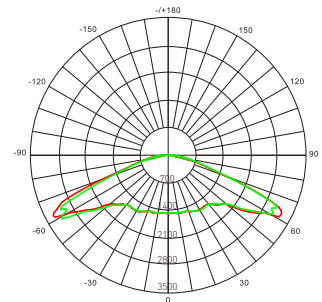

AVERAGE BEAM ANGLE[50%]: 150°
 UNIT:CD
 Lumens:9100LM
 Test Number:70W
 Test Number:5000K

— C0/180, 154
— C30/210,111.5
— C60/240,109.7
— C90/270,154.2

Installation Instruction

Installation method I : Ceiling Installation

1. Loosen the screw to take off the mounting plate from the lamp.

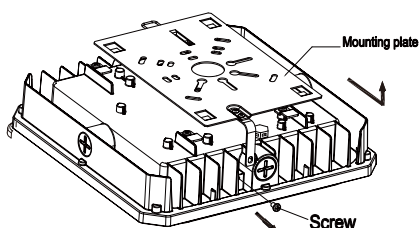

2. Screw the mounting plate to the ceiling.

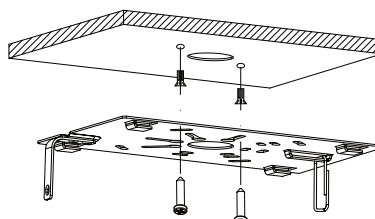

3. Hang the lamp on the ring so as to connect wires with terminal caps.

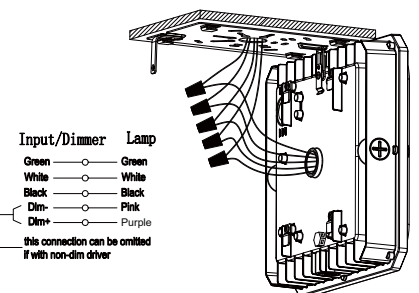

V4 Garage Parking Lot LED Light

4. Hook up lamp on the mounting plate.

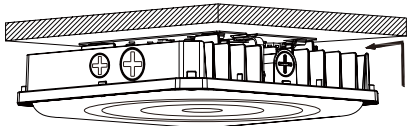

5. Secure the screw. Installation completed.

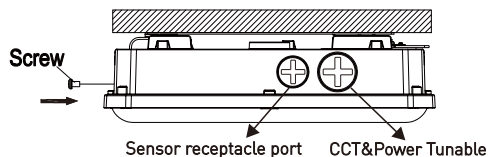

Installation method II: Pole-pendant Installation

1. Connecting wires with terminal caps as picture shows.

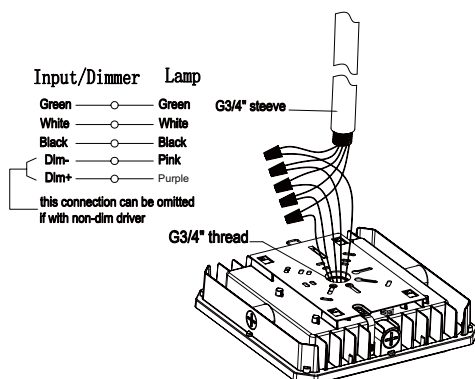

2. Rotating the sleeve to make it fixed with lamp. Installation completed.

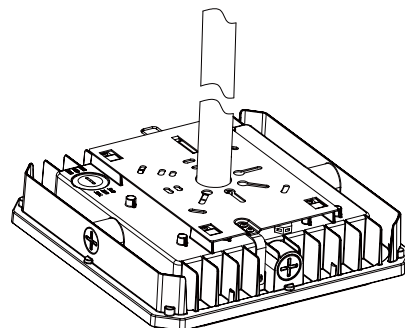

Plug sensor installation

1. Unscrew the PC cap on the lampshade counter-clockwise with a flat-head screwdriver on the lamp which already installed.

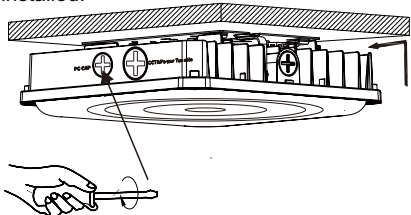

2. Screw the sensor clockwise by hands.

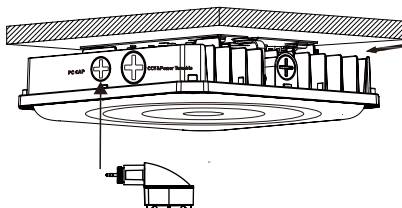

3. After tighten the sensor, Lighting the lamp, if the sensor works well, the installation finish.

