

# LED Architectural Wall Pack Series

Selectable Wattages: (28W/42W/56W/70W) (48W/72W/96W/120W)

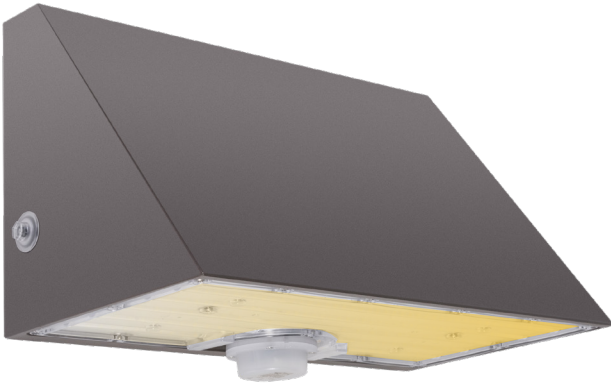

LED Architectural Wall Pack series can be widely used in indoor or outdoor lighting (wet location). Ideal for museums, art galleries, shopping malls, office buildings, walls and many other applications.

**WATT/CCT**  
SELECTABLE



## FEATURES

- LED high luminous efficiency and long working life.
- High efficiency LED Driver, the wide range input voltage AC120-277V.
- Die-cast aluminum cooling design, high quality and better cooling for LED  $T_j < 85^{\circ}\text{C}$ .
- Excellent optics design, greatly improve the light utilization and evenness.
- Photocell (Standard), Wireless bluetooth system and Motion sensor control available (Optional)
- 12Vdc auxiliary dimming
- The 1-10V Dimming type is continuous.

High performance, die-cast heat sink transfers heat from the light engine to the environment, drawing heat away from the fixture, and extending the lifespan of the LEDs.



## SPECIFICATION

WATTAGE	28W	42W	56W	70W	48W	72W	96W	120W
LUMEN	5211 lm	7048 lm	8901 lm	11156 lm	7759 lm	11257 lm	14447 lm	17148 lm
EFFICACY	170 lm/W	165 lm/W	160 lm/W	170 lm/W	170 lm/W	165 lm/W	160 lm/W	160 lm/W
CCT	3000K, 4000K, 5000K				4000K/5000K			
CRI	70							
INPUT VOLTAGE	AC120-277V							
BEAM ANGLE	Type III: 93.5° X 87.4° (option) / Type IV: 94.3° X 76.8° (standard) / Type V: 107.3° X 104.9° (option)							
POWER FACTOR	0.90							
DRIVER EFFICACY	90%							
FACTORY SETTINGS	70W & 4000K				120W & 4000K			
LIFE SPAN	over 50,000 hrs							
WORKING TEMPERATURE	-22°F ~ 113°F							
STORAGE TEMPERATURE	-40°F ~ 176°F							
OUTDOOR RATING	Wet location							
CABLE	3 core, 18AWG (0.3m)							
WARRANTY	5 year limited							

# LED Architectural Wall Pack Series

Selectable Wattages: (28W/42W/56W/70W) (48W/72W/96W/120W)

## DIMENSION

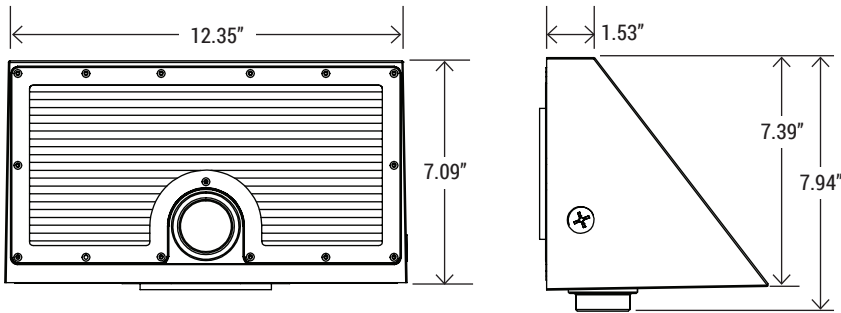

<b>WATTAGE</b>	28W-70W	48W-120W
<b>NT. WEIGHT</b>	8.14 lbs	8.60 lbs
<b>BOX DIM.</b>	13.58" x 7.87" x 8.27"	

## EMERGENCY BACK-UP (SOLD SEPARATELY)

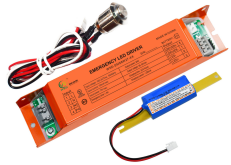

**WSD-EMS8W27-XX**  
8W Emergency Backup  
Battery LED Driver



**YH28A-08WL-180-X**  
8W Emergency Backup  
Battery LED Driver

## CONTROL (SOLD SEPARATELY)



**ANT-5-4T-BLE\***  
Bluetooth  
Microwave  
Motion Sensor



**ANT-5-4T**  
Bi-level  
microwave Sensor



**RC100**  
Remote  
Controller

**\*MESH RANGE** 60ft node-to-node and 500ft node-to-Gateway (Commissioning)

## PHOTOCELL STANDARD

P (Photocell)

**Bluetooth®**  
(Option)

**MOTION SENSOR  
and Bluetooth options**

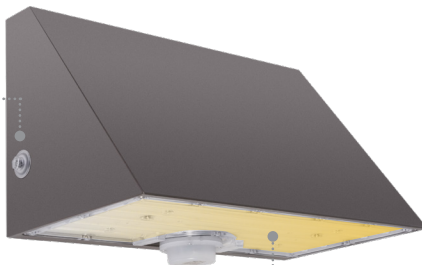

Optical lens is made of high quality PC material to make the light even and soft.

## WATT/CCT SELECTABLE



## ORDERING INFORMATION

EXAMPLE:

**WSD-AFW-2842567W27-345K-D-TN-P-M / WSD-AFW-48729612W27-45K-D-TN-P-M**

WSD	AFW	2842567W	27	345K	D	TN	P	M
COMPANY	PRODUCT	WATTAGE	VOLTAGE	CCT	FINISH	DISTRIBUTION	CONTROL	CONTROL
WSD LED INC	AFW LED Architectural Wall Pack	<b>2842567W -</b> (28W/42W/ 56W/70W) <b>48729612W -</b> (48W/72W/ 96W/120W)	<b>27</b> (AC120-277V)	<b>345K -</b> (3000K/4000K/5000K) <b>45K -</b> (4000K/5000K)	<b>D -</b> (Dark Bronze) <b>W -</b> (White) <b>B -</b> (Black) <b>S -</b> (Silver)	<b>T3 -</b> (Type III) <b>T4 -</b> (Type IV) <b>T5 -</b> (Type V)	<b>P -</b> (Photocell)	<b>M -</b> (Motion Sensor)

# LED Architectural Wall Pack Series

Selectable Wattages: (28W/42W/56W/70W) (48W/72W/96W/120W)



## DIMENSION

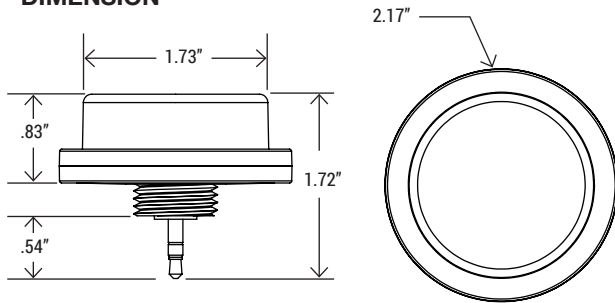

## COVERAGE

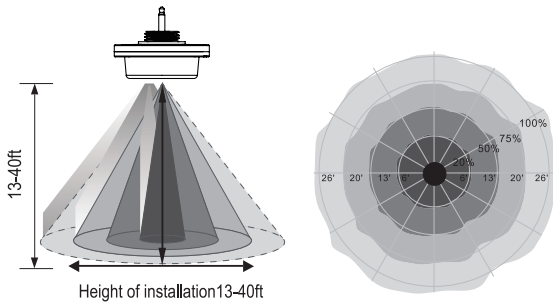

## MICROWAVE SENSOR FEATURES

DAYLIGHT HARVESTING	On/Off
MOTION SENSING	On/Off
FIRST TIME DELAY	1-59 mins/infinite
SECOND TIME DELAY	0-59 mins/infinite
DIM LEVEL	0-100%
MOUNTING HEIGHT	13-40ft
DETECTION RANGE	up to 52ft diameter
DETECTION: HORIZONTAL	360°
DETECTION: VERTICAL	90°

## ANT-5-4T-BLE

Plug and Play Network BLE Nodes and Sensor

The Bluetooth Lighting Control provides automated individual and group control of light fixtures using on sensors and Bluetooth mesh technology. The ANT-5-4T-BLE mounted in an Commercial lighting fixture and provides multi-level control solution based on motion and or daylight harvesting contribution.

## FEATURES

- Lighting controls meet design lights consortium (DLC) networked lighting control system technical requirements (Version NLC5 June 23, 2020).
- Quick connect and adjust different sensor angle.
- Easy commissioning with Tuya/Sharkward App (Available in IOS and Android).
- Bluetooth network with Saas working by computer
- Individual addressability and/or grouping.
- Time clock scheduling for individual lights, groups or scenes.
- Multi-level dimming: manual ON/OFF automatic ON/OFF, and automatic partial ON/OFF, daylight harvesting control capability.

## SPECIFICATION

NETWORK BLE MESH	Yes
DAYLIGHT HARVESTING	Yes
MICROWAVE MOTION SENSOR	Yes
DETECTION MODE	Occupancy/Vacancy/Bi-level in 1 Unit
OPERATING VOLTAGE	12-24V DC
OPERATING CURRENT	>50mA
SINKING CURRENT	max. 25mA
CONTROL OUTPUT	0-10V
RADIO FREQUENCY	2.4GHz ± 75MHz
WIRELESS STANDARD	BLE 4.2 MESH IEEE 802.15.1
PROGRAMMING	Tuya/Sharkward App mobile app (IOS and android) or Saas
CYBERSECURITY	UL 1376
ENCRYPTION	AES 128-bit
MESH RANGE	60ft node-to-node and 500ft node-to-device (Commissioning)
SAFETY	cULus Listed
FCC	FCC ID:2AVMOANT-5-X
OPERATING TEMP.	-40°F - +158°F (-40°C - +70°C)
IP RATING	IP65
WARRANTY	5 year limited

## COMMISSIONING

Tuya/Sharkward mobile App makes it easy to pair devices, create groups, set scenes/schedules, customize dimming levels, and adjust high trim based on application needs.



# LED Architectural Wall Pack Series

Selectable Wattages: (28W/42W/56W/70W) (48W/72W/96W/120W)

## GATEWAY REMOTE CONTROL

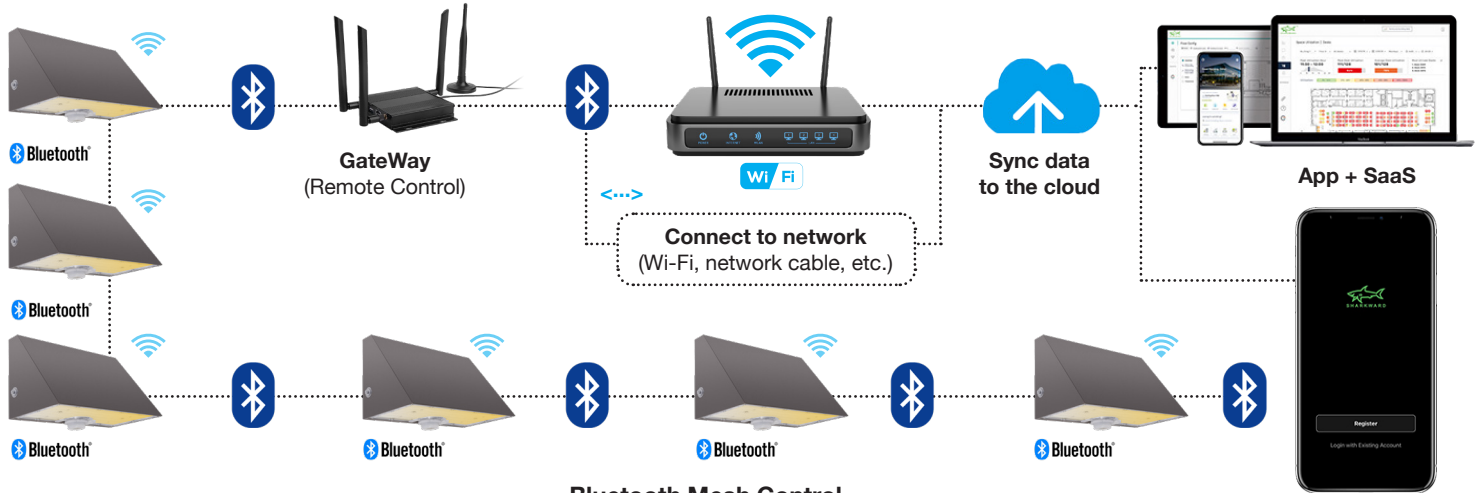

## Bluetooth Mesh Control

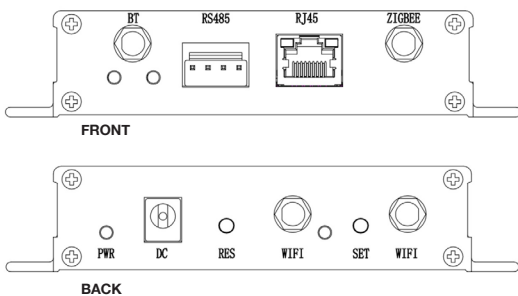

## INDUSTRIAL GATEWAY

### SK18WG

Smart Engineering Gateway

- One gateway can control max. 200pcs Bluetooth Motion sensors.
- This distance is for reference only, the construction site conditions are different, and the distance may deviate.
- The gateway can cover up to 500ft distance.
- Bluetooth between Bluetooth communication up to 60ft.

Consult factory for more details.

### SPECIFICATION

INPUT VOLTAGE	100-240VAC, 50-60Hz
OUTPUT VOLTAGE	5V= 2000MA
WORKING TEMPERATURE	-10°C ~ 45°C
STORAGE TEMPERATURE	-20°C ~ 60°C
WORKING HUMIDITY	10%-90%RH (No condensation)
STORAGE HUMIDITY	5%-90%RH (No condensation)
DIMENSIONS	4.25"x5.18"x1.07" (LxWxH)
WEIGHT	0.81 lbs

### RF CHARACTERISTICS

	WIFI	BLUETOOTH	ZIGBEE
WIRELESS FREQUENCY	2.400 ~2.4835 GHz	2.400 ~ 2.4835 GHz	2.400 ~ 2.480 GHz
NETWORK STANDARD	WIFI 802.11 b/g/n	IEEE 802.15	IEEE 802.15.4
TRANSMIT POWER	20dBm	8dBm	Nominal 10dBm, up to 19dBm
CHANNELS	CH1-CH14	CH0 - CH39	CH11-CH26
TRANSFER SPEED	11b:1,2,5,5, 11 (Mbps) 11g:6,9,12,18,24,36,48,54 (Mbps) 11n:HT20 MCS0~7 11n:HT40 MCS0~7	1Mbps/2Mbps	250Kbps

# LED Architectural Wall Pack Series

Selectable Wattages: (28W/42W/56W/70W) (48W/72W/96W/120W)

## PHOTOMETRICS

For complete IES files, please visit our website.

### WSD-AFW2842567W27-345K-D-T3 (70W@5000K)

LUMINOUS INTENSITY DISTRIBUTION DIAGRAM

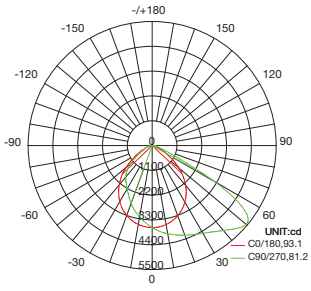

AVERAGE BEAM ANGLE(50%):87.1 DEG

CO PLANE ISOLUX DIAGRAM (UNIT:lx)

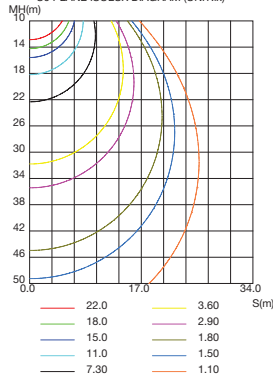

Flux out: 4903 lm

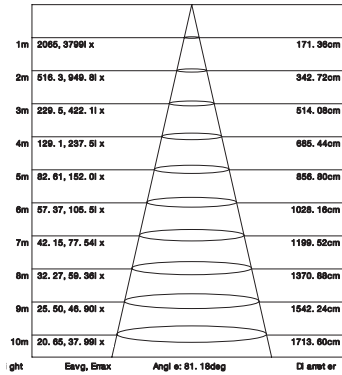

ISOLUX DIAGRAM

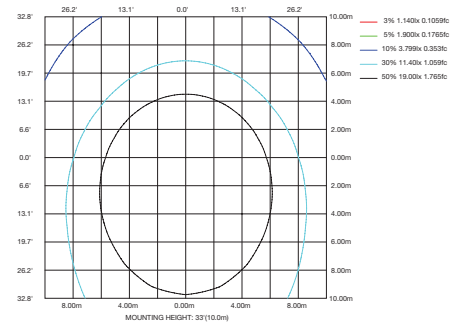

### WSD-AFW2842567W27-345K-D-T4 (70W@5000K)

LUMINOUS INTENSITY DISTRIBUTION DIAGRAM

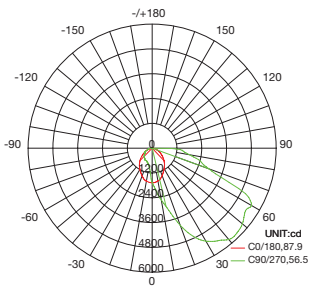

AVERAGE BEAM ANGLE(50%):72.2 DEG

CO PLANE ISOLUX DIAGRAM (UNIT:lx)

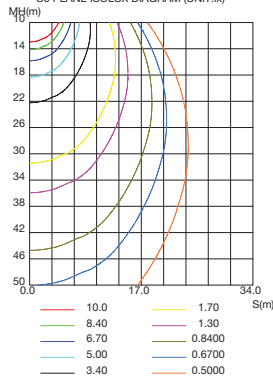

Flux out: 7445 lm

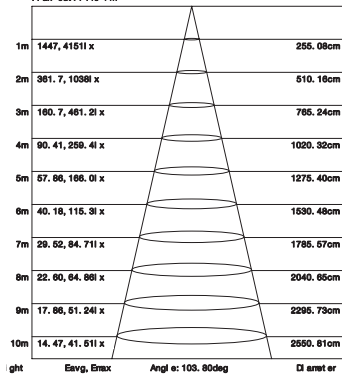

ISOLUX DIAGRAM

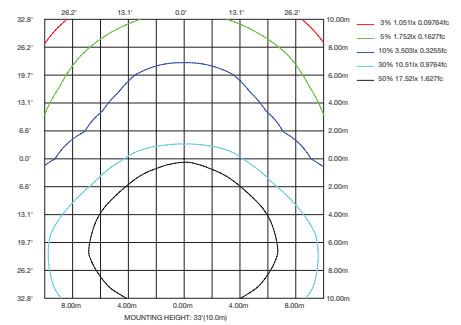

### WSD-AFW2842567W27-345K-D-T5 (70W@5000K)

LUMINOUS INTENSITY DISTRIBUTION DIAGRAM

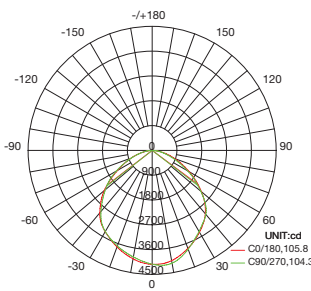

AVERAGE BEAM ANGLE(50%):105.1 DEG

CO PLANE ISOLUX DIAGRAM (UNIT:lx)

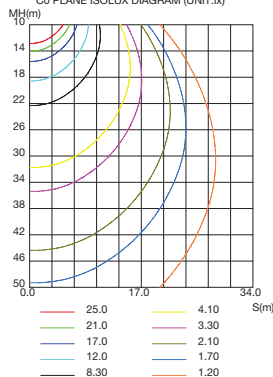

Flux out: 4903 lm

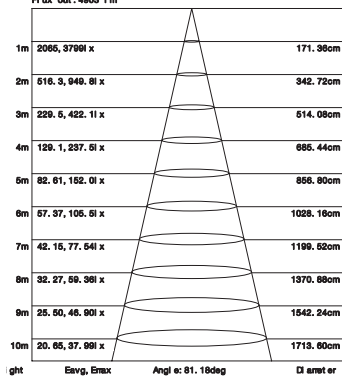

ISOLUX DIAGRAM

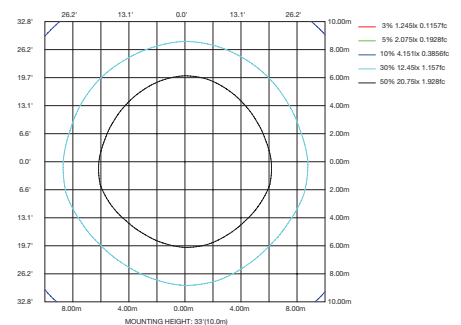

# LED Architectural Wall Pack Series

Selectable Wattages: (28W/42W/56W/70W) (48W/72W/96W/120W)

## PHOTOMETRICS

For complete IES files, please visit our website.

### WSD-AFW48729612W27-45K-D-T3 (120W@5000K)

LUMINOUS INTENSITY DISTRIBUTION DIAGRAM

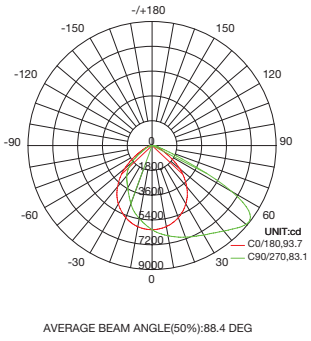

CO PLANE ISOLUX DIAGRAM (UNIT:lx)

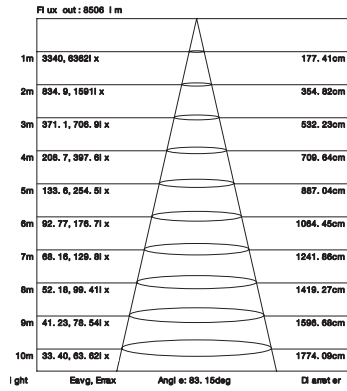
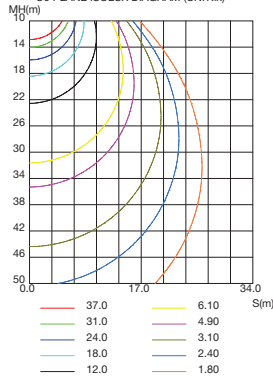

ISOLUX DIAGRAM

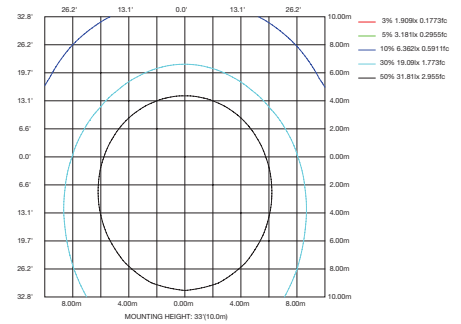

### WSD-AFW48729612W27-45K-D-T4 (120W@5000K)

LUMINOUS INTENSITY DISTRIBUTION DIAGRAM

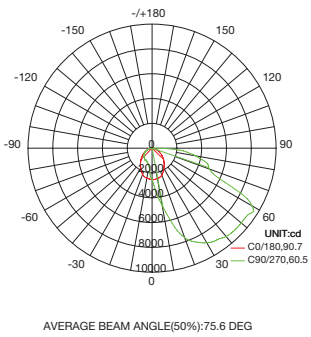

CO PLANE ISOLUX DIAGRAM (UNIT:lx)

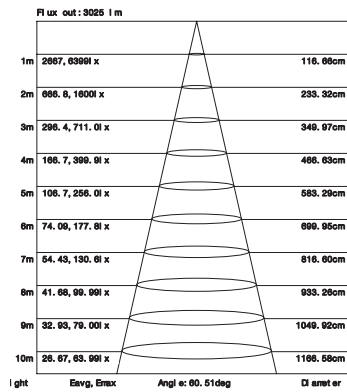
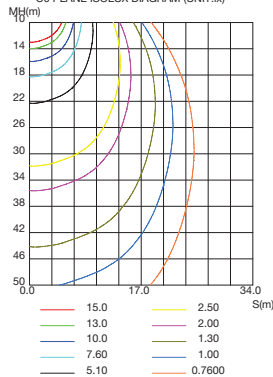

ISOLUX DIAGRAM

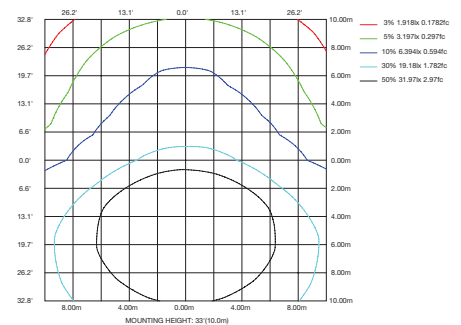

### WSD-AFW48729612W27-45K-D-T5 (120W@5000K)

LUMINOUS INTENSITY DISTRIBUTION DIAGRAM

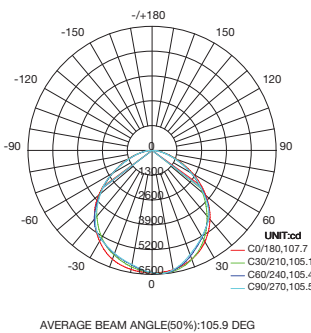

CO PLANE ISOLUX DIAGRAM (UNIT:lx)

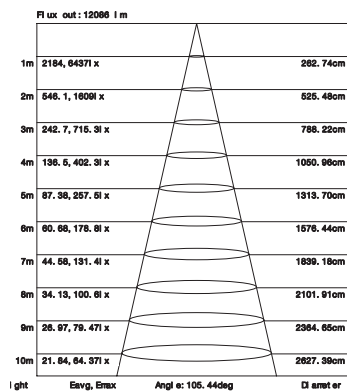
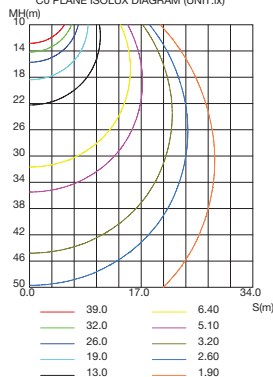

ISOLUX DIAGRAM

